

1 Parasitten. AMFI

2 møte/selskap

3 møte/selskap

4 foajé/kafé

5 terrasse

6 sanitær/garderobe

7 kjøkken

HØVEDBYGG - "PERISKOP"

SERVICE BYGG

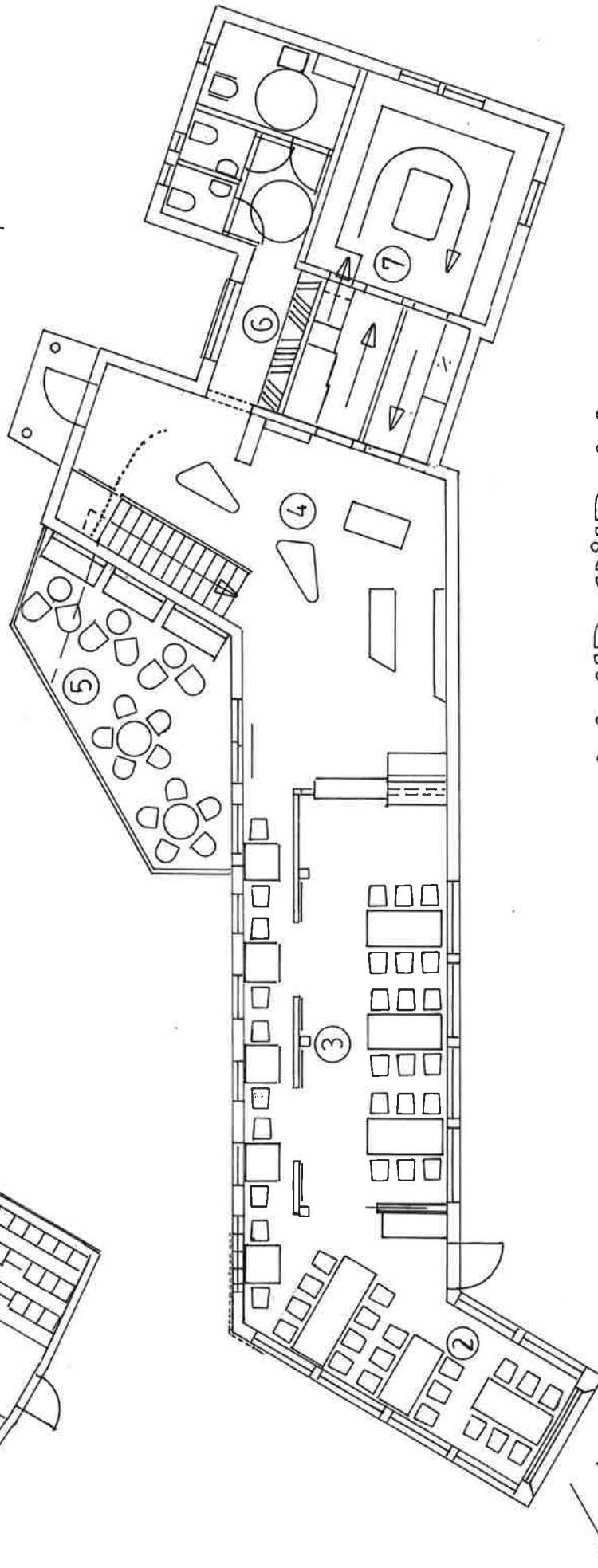
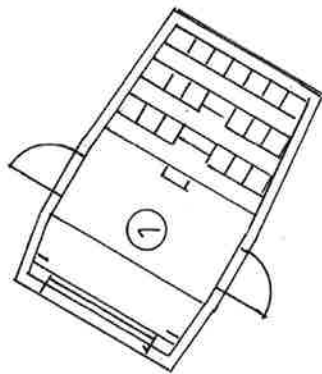

ANDØRJA ADVENTURES

PLANLØSNING ALTERNATIV A restaurant/kafé
9.3.16 ertikplus s⇒



1B

utendørliggende metallprofiler

3.5°

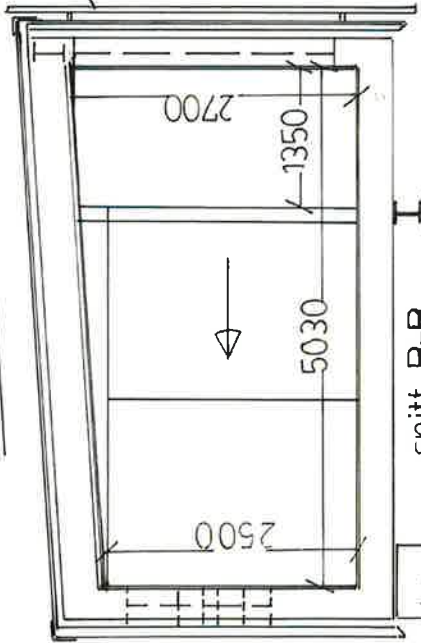

snitt B-B

snitt akse ①

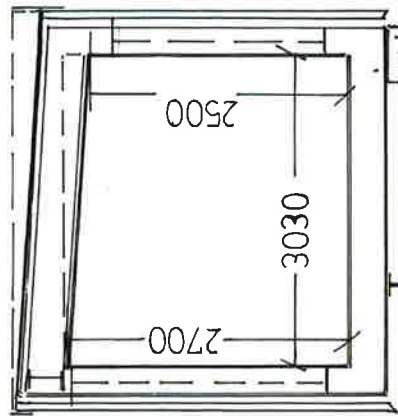

snitt A-A

3.5°

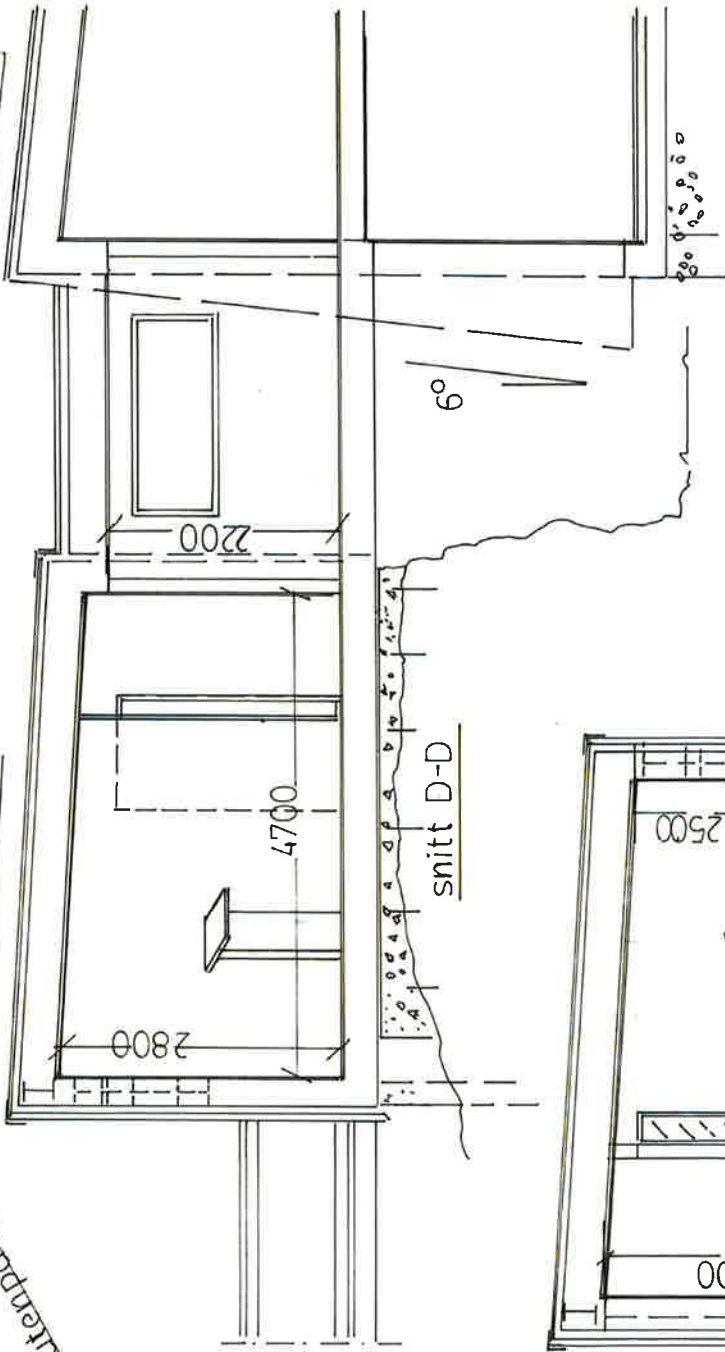

snitt D-D

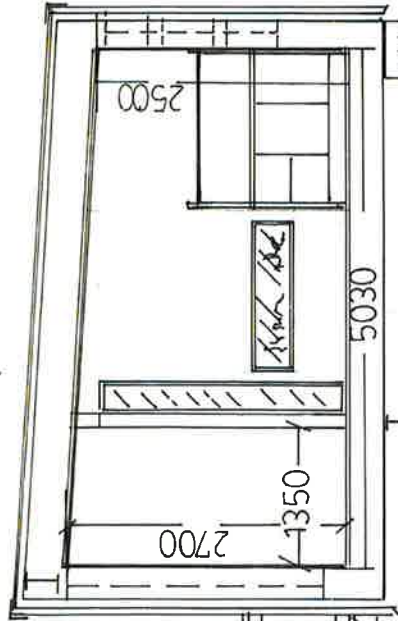

snitt C-C

ANDØRJA ADVENTURES
SNITT ABCD HOVEDBYGG
mål 1:50
revidert 31.3.16 erikpluss as

3

2

20

ANDØRJA ADVENTURES
"OPPLEVELSESBOKS"
mål 1:50
14.3.16 erlikpluss

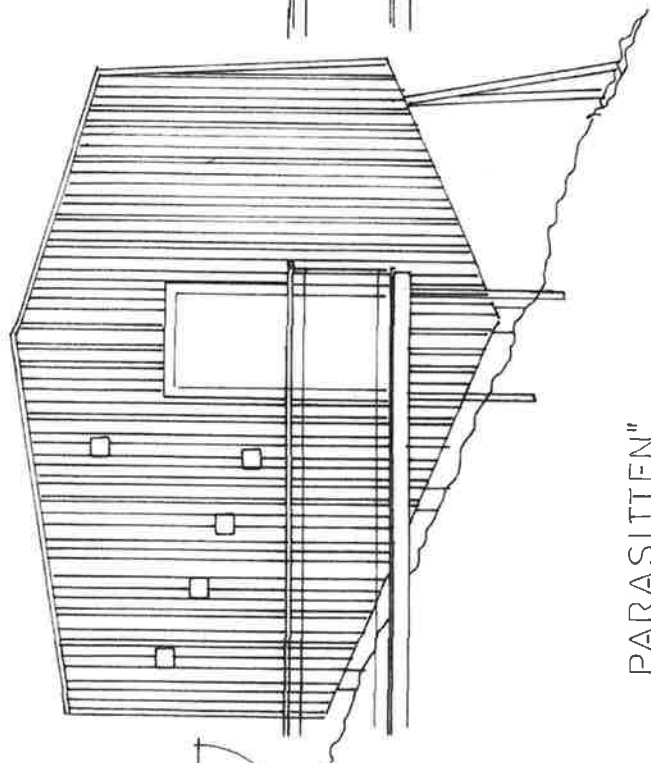
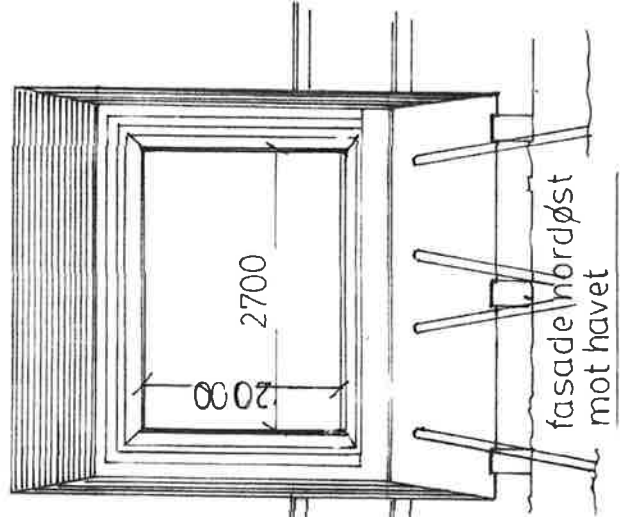
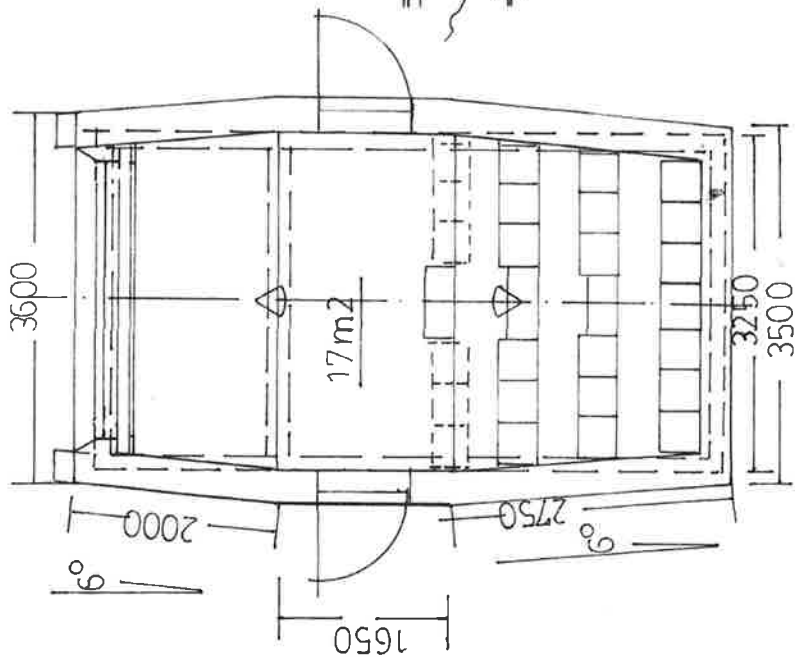

"PARASITTEN"

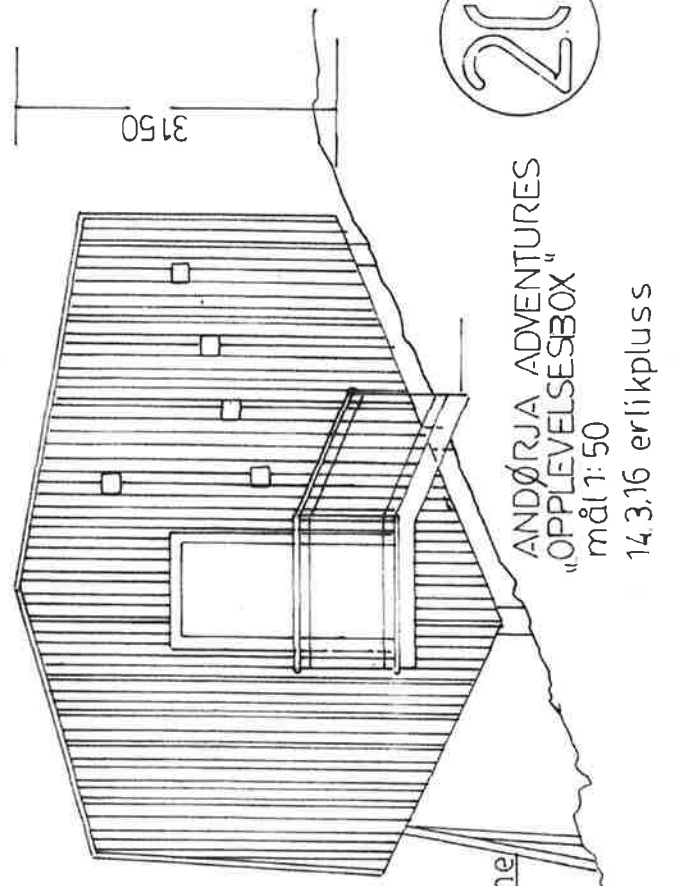
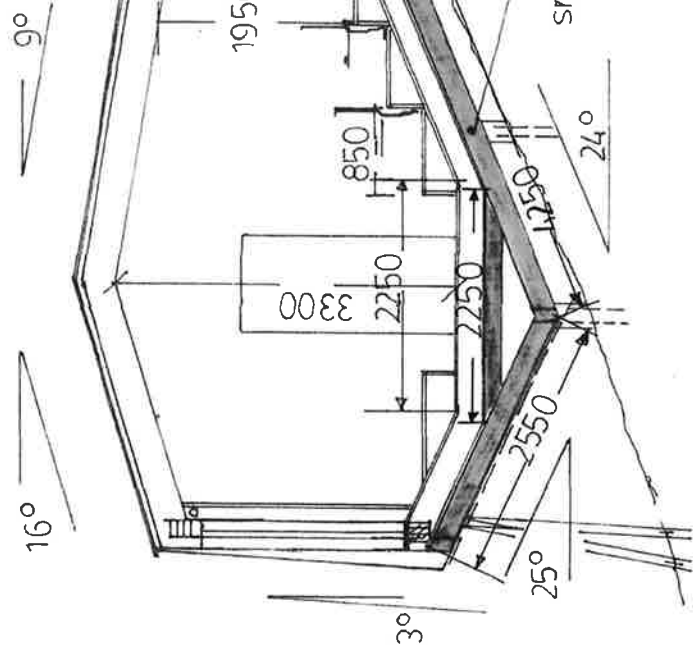

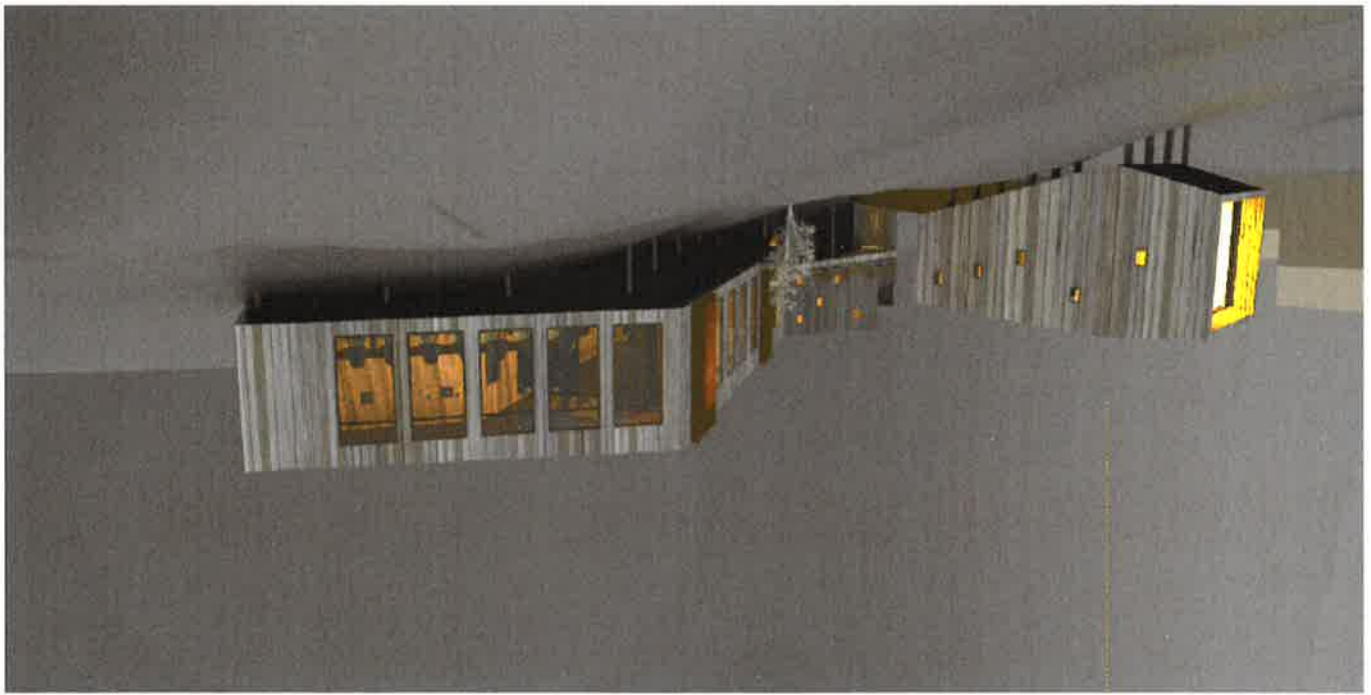



FORSLAG TIL REGULERINGSPLAN ANDØRJA ADVENTURES, ENGENES
Planid. 1917 - 2017002. Illustrasjoner av planlagt opplevelsessenter v/ ERLIKPLUSS AS